



ALSONIC-FX

Ultrasonic Flowmeter Model Alsonic-FX

GENERAL

ALSONIC-FX series is a fixed mounted,transit-time ultrasonic flowmeter, with clamp-on transducers for non-invasive liquid measurement. Our microprocessor based,user friendly,field programmable flow measurement technique allows no interruption of the process flow and has low instalation costs.



FEATURES

- ❑ 2 line LCD display with flowrate, totalizer & signal condition.
- ❑ Stores up 64 Day/months Totalizer daily value
- ❑ Batch control function
- ❑ Wide range velocities of 0.01 ~ +/- 32 m/s.
- ❑ Transducers for pipe size form 13 to 6000 mm.
- ❑ High accuracy of +/-0.5% of reading.
- ❑ Transducers include magnet devise,for installation on metal pipe without mounting belt.
- ❑ Data logger function, include date, totalizer, signal condition.. Etc.
- ❑ Response time less than 1 second.



SPECIFICATION

- Measuring Principle : Transit time difference
- Pipe Size : S Type : 15 mm ~ 100 mm (1/2" ~ 4")
: M Type : 50 mm ~ 700 mm (2" ~ 28")
: L Type : 300 mm ~ 6000 mm (12" ~ 240")
- Pipe Material : Cast Iron, Stainless Steel, Ductle Iron
Copper, PVC, Aluminum, Asbestos
Fiberglass... etc.
- Liner Material : Tar Epoxy, Rubber, Mortar, Polypropylene,
Polystryal, Ploystryene, Polyester, Ebonite,
Polyethylene, Teflon... etc.
- Display : 2 Line LCD with illumination.
Flowrate : 5 digit with decimal point
Totalizer : 8 digit, Forward, Reverse & Net values.
Engineer Unit : M3, Liter, US Gallon, Imperial Gallon,
Million Gallon, Cubic Feet, US Barrels,
Imperial Barrels, Oil Barrel.
Time Unit : Second, Minute, Hour, Day.
Other : Velocity, Date, Time, Signal condition.
- Accuracy : +/- 1% ~ +/- 2% of reading(0.5 ~ 30 m/s)
: +/- 0.5% of reading (online calibration)
- Repeatability : +/-0.2% of reading
- Keypad : 16 Key with tactile action
- Response Time : Less than 1 second
- Flow Velocity : 0.01 ~ +/- 32 m/s
- Resolution : 0.0001 m/s
- Ambient Temperature : -20 ~ +50 °C
- Mounting : wall mounting, panel, local
- Max. Cable Length : 150 M
- Power Consumption : Less than 2W
- Power Supply : 90 ~ 260Vac 50/60 Hz
- Data Storage : Operation parameters and totalization
date are stored by EEPROM for more
than 10 years
- Output : 4-20 mA or 0-20 mA
- Pulse Output : 1- 9999 Hz
- Data Logger : 64 data include flowrate, totalizer,
time, date.
- Alarm : High/Low with buzzer
- Communication : RS-232
- Dimension : 235 * 205 * 95 mm
- Weight : 1.5 Kg
- Protection

Converter : IP65

Sensor : IP68(Submersible)

SmartMeasurement.

2960 Polk St. Suite 12, San Francisco, CA 94109 USA
TEL : +1- 415 - 673 - 0143 FAX : +1- 415 - 673 - 4416

TRANSDUCER SPECIFICATION

Standard-Transducers

Fluid Temperature : -30 ~ +90 °C

Accuracy: 1%

Model	SCS (Small Size)	SCM (Medium Size)	SCL- (Large Size)
Pipe Size	DN15-100mm	DN50-1000mm	DN300-6000mm
A×B×C	45mm*23mm*25mm	64mm*32mm*35mm	98mm*45mm*49mm

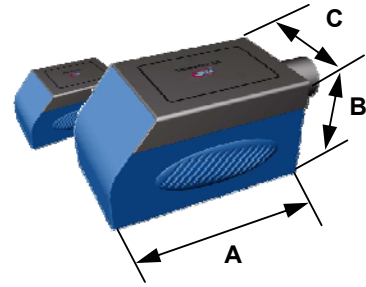

Insertion Transducers

Fluid Temperature : -40 ~ +160 °C

Accuracy: 1%

Model	SIS (Standard)	SIL (Large Size)
Pipe Size	DN80-1000mm	DN300-6000mm

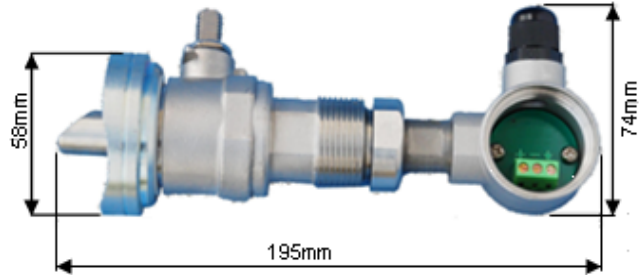

High Temperature Transducers

Fluid Temperature : -30~160 °C

Accuracy: 1%

Model	STS (Small Size)	SHL (Medium Size)
Pipe Size	DN15-100mm	DN50-1000mm



Inline Type

Fluid Temperature : -40~160 °C

Accuracy: 0.5%

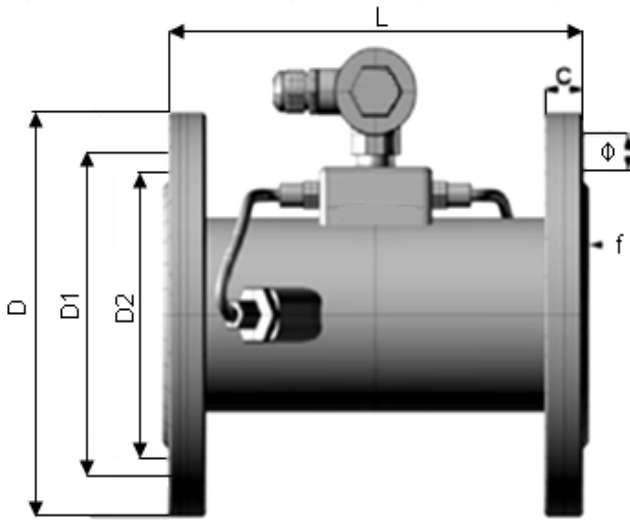

DN	L	D	D1	φ×n	D2	f	C
50	200	165	125	18×4	99	3	20
65	200	185	145	18×4	118	3	20
80	225	200	160	18×4	132	3	20
100	250	220	180	18×8	156	3	22
125	250	250	210	18×8	184	3	22
150	300	285	240	22×8	211	3	24
200	350	340	295	22×12	266	3	24
250	450	405	355	26×12	319	3	26
300	500	460	410	26×12	370	4	28
350	550	520	470	26×12	429	4	30
400	600	580	525	26×16	480	4	32
450	700	640	585	30×20	548	4	34
500	800	715	650	33×20	609	4	36
600	1000	840	770	36×20	720	5	38
700	1100	910	840	36×24	794	5	40
800	1200	1025	950	39×24	901	5	42
900	1300	1125	1050	39×28	1001	5	44
1000	1400	1255	1170	42×28	1112	5	46

Note:all dimensions are mm unless stated

OTHER ACCESSORY



Measuring Tape



Stretcher



Silicone grease



Thickness gauge



Cable

➤ DIMENSIONS

● **Wall Mount**



cast aluminium
IP65

Size: 180x170x56mm

Setting data: flow unit, zero, clear total flow, K-factor, passwords, date, linearity factor

Input: 3 channel 4-20mA analog input, 2 channel resistance signal input

Output: Isolation RS232/RS485 output, 2 channel isolation OCT output, 1 channel isolation 4-20mA output (tow-wire)

● **Panel Mount**



Size: 165x160x80mm

Setting data: flow unit, zero, clear total flow, K-factor, passwords, date, linearity factor

Input: 3 channel 4-20mA analog input, 2 channel resistance signal input

Output: Isolation RS232/RS485 output, 2 channel isolation OCT output, 1 channel isolation 4-20mA output (tow-wire)

● **Mini**



Size: 106x48x34mm

Display: 1. state, 2. error time, 3. temperature different, 4. temperature, 5. energy flow, 6. total flow, 7. flow rate, 8. positive total flow

Output: RS485

Protection: IP68

● **Compact**



Display: 1. state

- 2. error time
- 3. temperature different
- 4. temperature
- 5. energy flow
- 6. total flow
- 7. flow rate
- 8. flow rate

Size: 96x96x129mm

Input: 3 channel 4-20mA analog input, 2 channel resistance signal input

Output: Isolation RS232/RS485 output, 2 channel isolation OCT output, 1 channel isolation 4-20mA output (tow-wire)

Protection: IP68

➤ STRAIGHT RUN PIPING REQUIREMENT

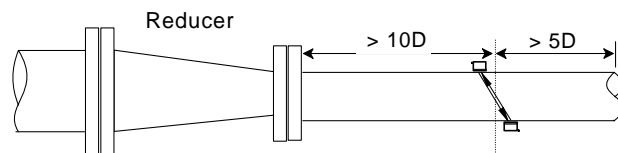
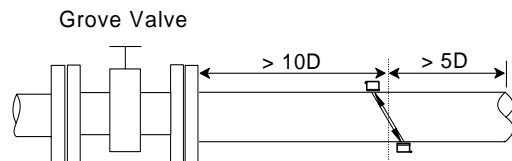
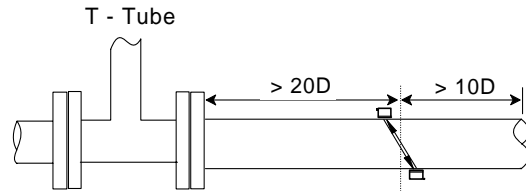
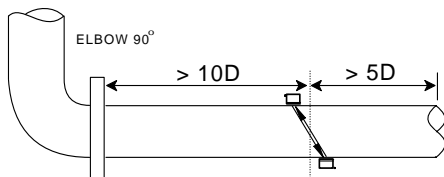

INSTALLATION

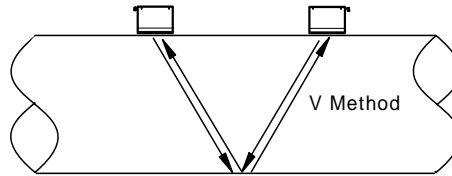
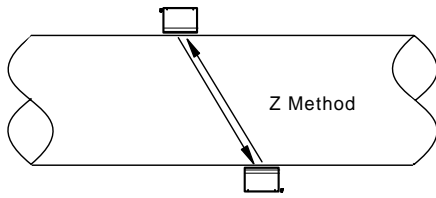







**** Please contact your local SMC application engineer**

You also need to provide the following information:

Type of Fluid	We need the name of your fluid, including operating density and viscosity
Line Size	pipe size and sensor connection type (insertion,clamp, etc..)
Process Pressure and Temperature	We calibration your Flowmeter as close to your application as possible
Type of Electronics	output and install type (compact, wallmount, panelmount,etc..)
Pipe Material	We need the name of your pipe material

Model Selection Guide

Alsonic-FX							
Example 1: Alsonic-FX-compact-SCS-05-P1							
Alsonic-FX-	**	**	**	**	**		Description
Compact type with display and RS485 	MIF						Flow meter
Compact-multichannel with display,RS232/RS485,OCT output,4-20mA output 	CPF						
Wall mount with display, mulitchanel input/outputs 	WLF						
Panel mount with display, multi-channel input/output 	PMF						
Small clamp sensor, 15 ~ 100 mm		SCS					Transducers
Middle clamp sensor, 50 ~ 1000 mm		SCM					
Large clamp sensor, 300 ~ 6000 mm		SCL					
High Temperature clamp sensor (-30-160°C), 15 ~ 100 mm		SHS					
High Temperature clamp sensor (-30-160°C), 50 ~ 1000 mm		SHL					
Standard insertion sensor		SIS					
Long insertion sensor		SIL					
Inline sensor with pipe size ***		SN-***					
No Cables				NC			Signal Cable Length
5M, 2 Cables				C1			
10M, 2 Cables				C2			
15M, 2 Cables				C3			
Wall mount transmitter 					TW		Transmitter
Panel mount transmitter 					TP		
None transmitter					NN		
thinkness gague						TT	Options