

# MICROWAVE TYPE FLOW SENSOR **KFD SERIES**

*Owing to 24GHz super-sensitive  
and reliable*

*Non-contact  
flow sensing technology*

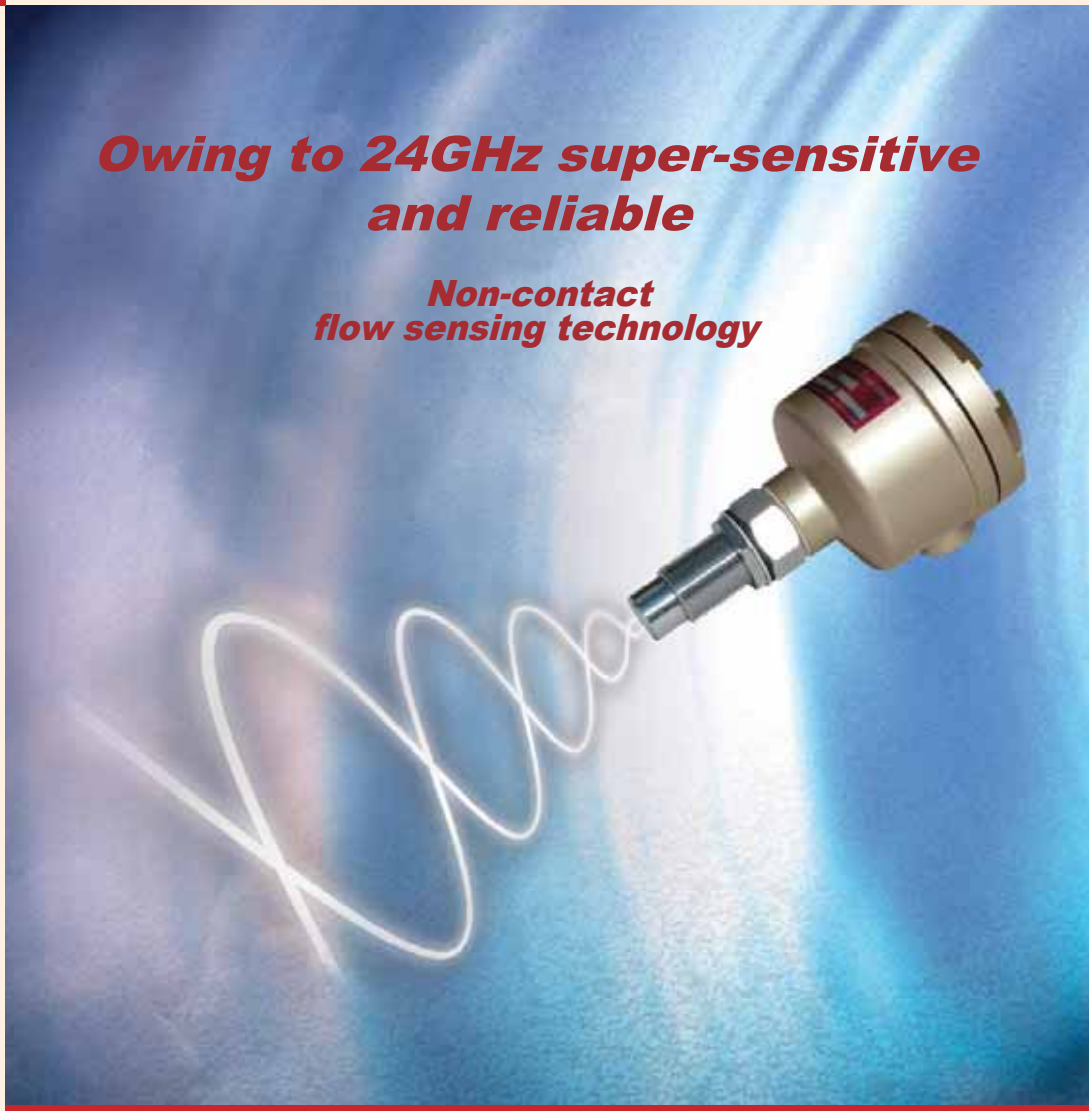

**Even a grain detected!**

# KFD-1 MICROWAVE TYPE FLOW SENSOR

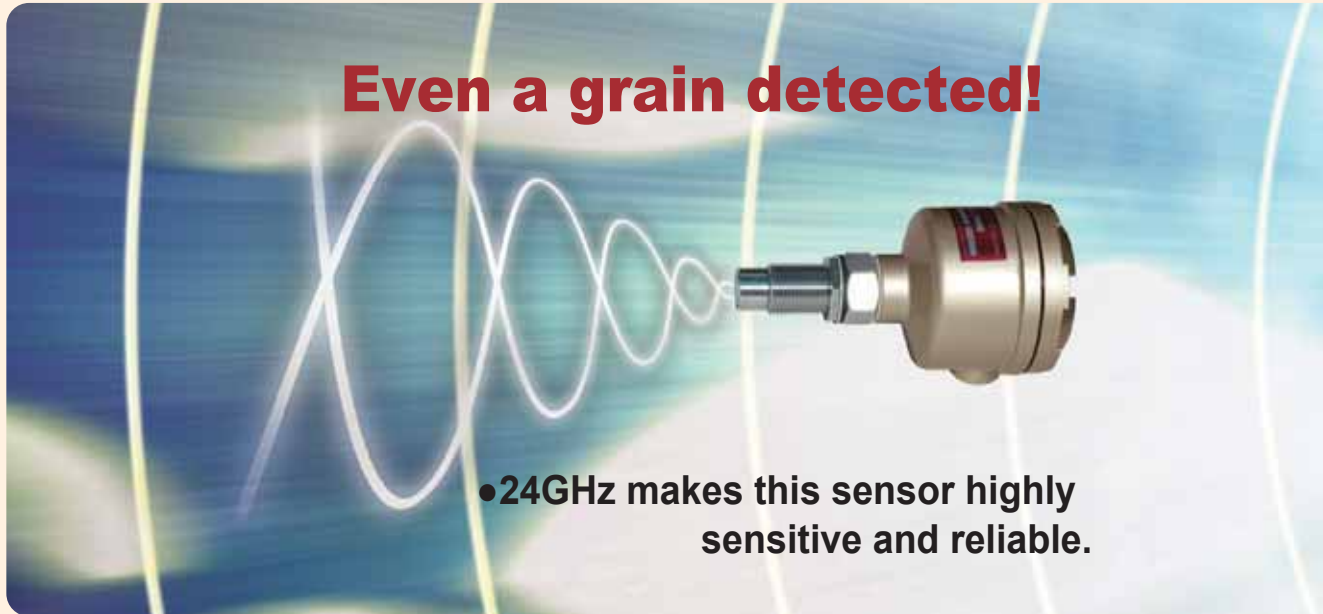

**Even a grain detected!**

●24GHz makes this sensor highly sensitive and reliable.

## ■ FEATURES

### ●Super-sensitive

Our unique circuit technology has been upgraded not to overlook even a grain.

### ●Non-invasive

Our 24GHz technology has made it possible to sense through an intermediate barrier such as glass or synthetic resin.

### ●Fouling

It may not be affected by smudges on the sensing surface or scale adhesion due to our 24GHz technology.

### ●Versatility

It can detect flow in both small and large quantity if its sensitivity is adjusted.

## ■ OPERATING PRINCIPLE

Model KFD-1 is a Non-contact Flow Sensor which emits the microwaves of 24GHz from the tip of its sensor. Reflected from the surface of powders and solids traveling in a pipeline, the microwaves get modulated in their frequency on the Doppler effect principle. The sensor, detecting the frequency difference between transmitted and reflected microwaves, transforms it and amplifies to output contact signals. It can reliably detect a little flow or motion of the powder or the grain in chutes or pneumatic conveying lines, which has so far been considered to be very difficult.

## ■ SPECIFICATIONS

**Model** : KFD - 1

**Power Source** : 105/210VAC ±10% 50/60Hz

**Supply voltage** : 5VA

**Sensing distance** : Max.1.5m (depend on object)

**Wave modulation** : NON

**Frequency** : 24.2GHz

**Power output** : 5.5mW

**Output contact** : 1×SPDT 250VAC 5A  
Fault Alarm (Option)

〈Activated 6 seconds after detecting a weak oscillation or operation stop〉

**ON delay** : Variable 10 sec at the max.

**OFF delay** : Variable 10 sec at the max.

**Acceptable temp** : -10 ~+55°C

**Housing** : IP-66 equivalent

**Color** : Gold

**Weight** : about 1.5kg

**Allowable pressure** : 490kPa

## OUTLINE DRAWING

### STANDARD

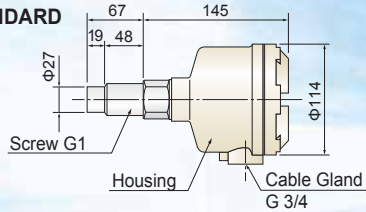

### HEAT RESISTANT (MAX 120°C)

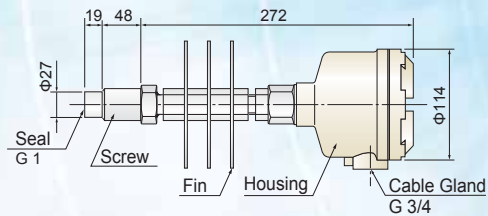

## WIRING

### STANDARD

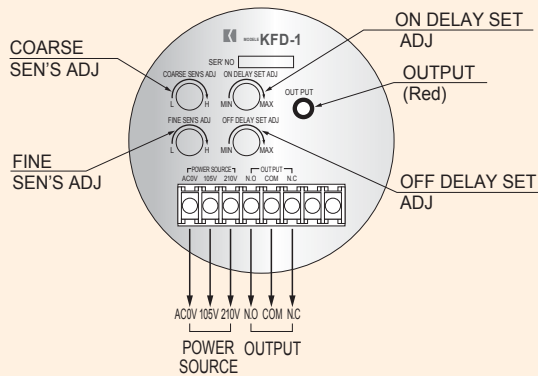

## OPTION

### with Optional Fault Alarm

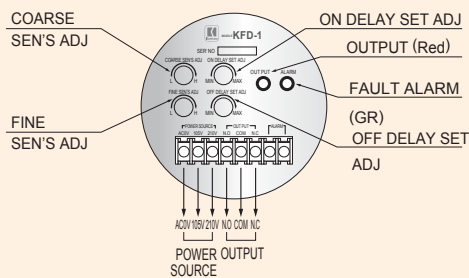

The Output LED may not be affected by Delay Setting (ON, OFF) but turn on or off following flow or no flow. Therefore, Sensitivity Adjustment and Delay Setting can be easier in such a process as turbulent flow.

# KFD-2

## MICROWAVE TYPE FLOW METER



- Flow Meter with continuous output (4-20mADC)
- This can retrieve such a minute change in concentration that KFD-1 has not been able to do.

## SPECIFICATIONS

Model : KFD-2

Supply voltage : 105/210VAC±10%  
50/60Hz

Signal output : 4-20mADC

Acceptable temp : -10 ~ +55°C

Color : Gold

Allowable pressure : 490kPa

Load resistance : less than 300Ω

## OUTLINE DRAWING

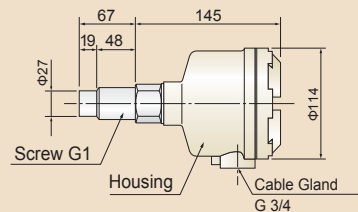

## WIRING

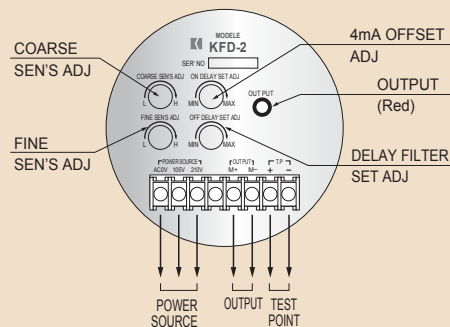

## APPLICATIONS

Apply the instrument to a spot shielded with metal and so on.

### KFD-1

- **LEAKAGE DETECTION**  
-damper shut or not

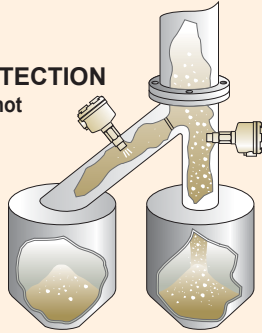

- **FLOW DETECTION**  
-at the chute of bucket elevator

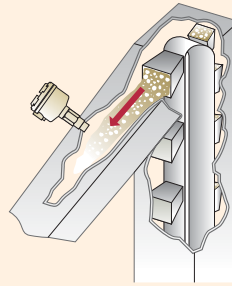

- **CHARGING LINE**  
-objects supplied or not.  
quality managing

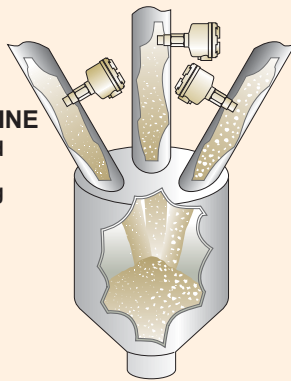

- **FLOW OR BLOCKAGE DETECTION**  
-autoloader or pneumatic conveyer

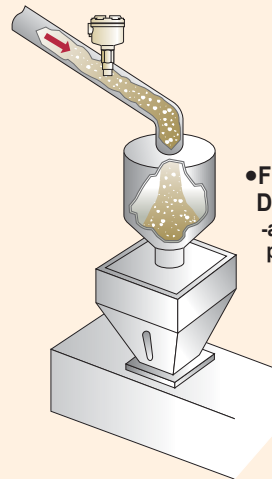

### KFD-2

- **CHARGING LINE**  
-clog detection

When either one of charging lines is clogged, it continuously detects the decrease of concentration ratio of either product supplied.

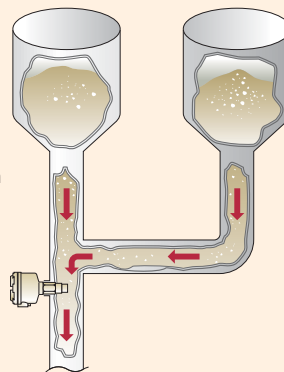

## Line of business

- Rotary Paddle Type Level Switch
- Vibration Type Level Switch
- Swing Type Level Switch
- Acoustic Level Switch
- Capacitance Type Level Switch
- Capacitive Proximity Sensor
- Capacitance Type Level Indicator
- Diaphragm Type Level Switch
- Tilt Switch
- Leak Type Level Switch
- Microwave Switch
- Sounding Bob Type Level Indicator
- Flow Switch
- Conductance Type Level Switch
- Float Switch
- Float Type Level Indicator
- Ultrasonic Type Level Indicator
- Equipments For Conveyor Lines
- Dust Monitor System
- Zirconia Oxygen Analyzer
- Laser Type Level Indicator
- RADAR Type Level Indicator
- On-line Sensors for Accurate Liquid Analysis
- Ultrasonic Flow meter

\*Please be sure to read USER'S GUIDE, Installation & Operation Instructions before using the instrument.

\*The specifications herein may be subject to change without advance notice.

Nuclear Power Generation to Rice Milling  
All-round Manufacturer of Level Controllers for Powder, Granules and Liquid

**KANSAI Automation Co., Ltd.**

Headquarters :  
2-14, Togano-cho, Kita-ku, Osaka 530-0056, Japan  
TEL. 81-6-6312-2071 FAX. 81-6-6314-0848  
e-mail: info@kansai-automation.co.jp

<http://www.kansai-automation.co.jp>

Tokyo Branch : 1-29-6, Hamamatsu-cho, Minato-ku, Tokyo 105-0013, Japan  
TEL. 81-3-5777-6931 FAX. 81-3-5777-6933

Nagoya Office : 3-31-27, Uchiyama, Chigusa-ku, Nagoya 464-0075, Japan  
TEL. 81-52-741-2432 FAX. 81-52-741-1588

Kyushu Office : 1-2-39, Asano, Kokura Kita-ku, Kitakyushu 802-0001, Japan  
TEL. 81-93-511-4741 FAX. 81-93-511-4580



Design, development, and manufacture of level measuring sensors

Agent